

Data Sheet

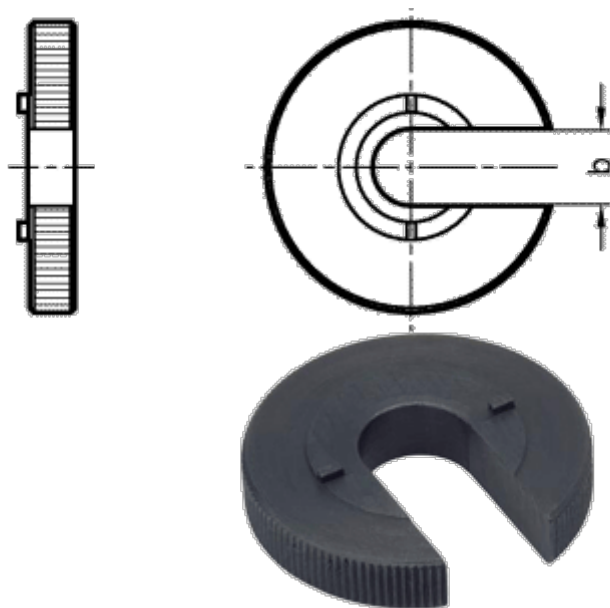

Article number: 20892005
Description: E+G Tool for GN 613
GN 613.1-8

Measures



b = 8 mm